



ParkView™
Signature Kitchen™



KINDRED

OUTDOORS + SURROUNDS



Outdoor Luxury Made Simple, In Just 5 Steps!

Kindred Outdoor Signature Kitchens are an easy solution to creating the timeless look and feel of a stone masonry kitchen. Each Kindred Outdoor Signature Kitchen ships complete with all the necessary cabinets, bolts, and end-caps. Finalize your outdoor kitchen by selecting the appliances and countertop of your choice. Customize your design by dressing it with an application of stone, brick, natural veneer, or stucco. Visit www.ElevateWithStone.com to learn more.

Please note: Countertops, appliances and finishes are not sold through Kindred Outdoors + Surrounds.



1

PRE-PLANNING & DESIGN

- Determine location of outdoor kitchen
- Specify finish, appliances & countertop materials
- Install utilities—gas, water, electrical, drainage
- A minimum 4" concrete or paver foundation is needed to support kitchen

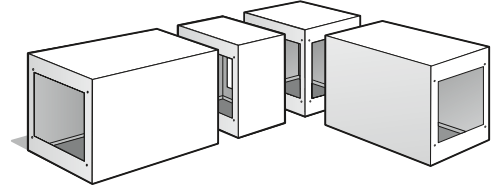

2

INSTALL KINDRED OUTDOOR CABINETS

- Place Kindred Outdoor cabinets in designated area
- Level, glue and bolt cabinets together

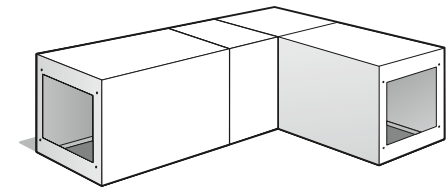

3

CUT APPLIANCE OPENINGS

- Follow appliance manufacturer's install instructions
- Cut Kindred Outdoor cabinets with 4" diamond masonry blade
- Install doors & drawers in advance of stone or brick installation

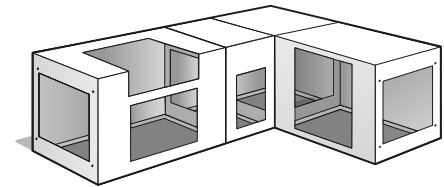

4

INSTALL APPLIANCES & COUNTERTOP

- Install an appropriate outdoor countertop surface such as tile or granite
- If selecting a solid surface such as granite, it is recommended you work with a local fabricator

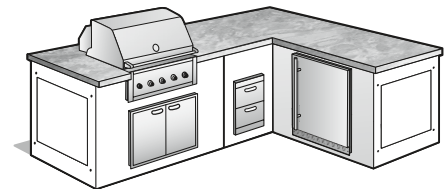

5

INSTALL STONE OR BRICK

- Install your choice of finish directly to the pre-scratched Kindred Outdoor cabinets
- Follow the recommended installation guidelines provided

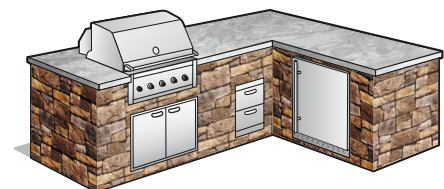



DIMENSIONS

Individual Cabinets

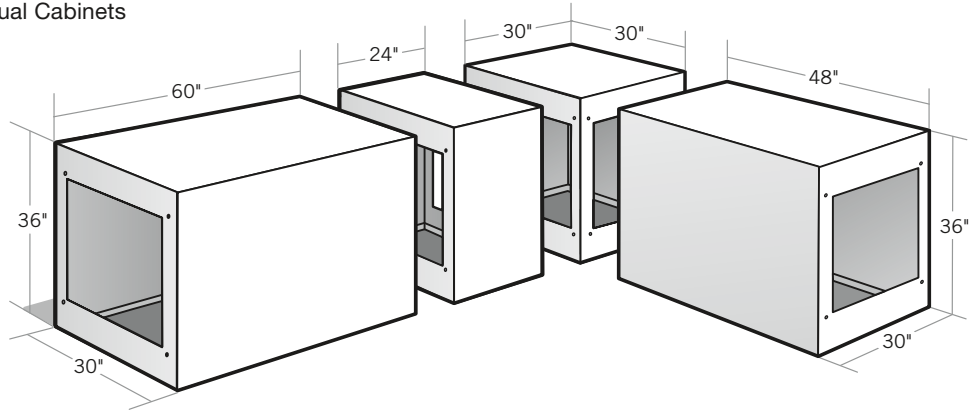

Overall Kitchen

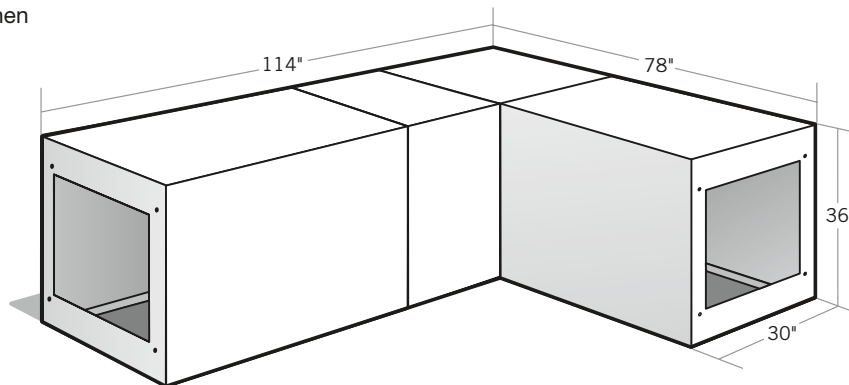

INVENTORY LIST

ITEM	QTY.
24" Straight Cabinet	1
48" Straight Cabinet	1
60" Straight Cabinet	1
90° Corner Cabinet	1
Cabinet End-Caps	2
Fastener Sets	3
Vents	2

Appliance Brackets sold separately. Brackets are used for mounting appliance doors & drawers.



MATERIALS & TOOLS REQUIRED

- ❑ Grinder with Diamond Blade
- ❑ Crescent Wrench & Socket Set
- ❑ Construction Adhesive
- ❑ Level
- ❑ Shims



1

PRE-PLANNING & DESIGN

- Review the provided Signature Kitchen specifications and any additional products such as appliances and countertops before beginning installation.
- Determine location of Kindred Outdoor Signature Kitchen. Please note that a minimum 4" concrete or paver foundation is needed to support kitchen.
- Select stone or brick finish, appliances & countertop materials.
- When choosing appliances, note that appliances cannot be bridged between cabinets and you must leave 2" of material on each side of the cabinet.
- If selecting a solid surface for the countertop such as granite, it is recommended you work with a local fabricator.
- Install necessary utilities such as gas, water, electrical, and drainage per your local building codes.
- Always refer to the appliance manufacturer's specifications for installation guidelines.



2

INSTALL KINDRED OUTDOOR CABINETS



- A** Place each selected cabinet in its approximate location to create the desired layout.
- B** Loosely place bolts in pre-drilled interior bolt holes located in each cabinet section.
- C** Ensure cabinet surfaces are level and line up with each other. Note: If necessary, place shims under the cabinets to line up and level each section.
- D** Run a bead of construction adhesive between each cabinet prior to bolting them together.
- E** Finish initial installation by tightening each bolt.

OPTIMAL MOUNTING TECHNIQUES

For out-of-level decks or other surfaces, grouting between an existing slab and the lower edge of the cabinets may be beneficial. Using masonry anchors or foundation bolts can further secure the unit. Do this by drilling through the lower edge into the concrete slab, insert the masonry anchors, then tighten. Repeat around the base of the entire unit.



3

CUT APPLIANCE OPENINGS



Before you begin, always refer to the appliance manufacturer's specifications for their installation guidelines.

- A** Use the manufacturer's dimensions or, better yet, the actual appliance to take measurements.
- B** Mark areas where appliance cut-outs are necessary on cabinets. Note that appliances cannot be bridged between cabinets and you must leave 2" of material from each side of a cabinet. *Be sure to account for the thickness of the countertop when drawing the marks or you may make the height of the cut too big—resulting in a large gap below the grill.*
- C** Using a grinder with a diamond blade, cut out marked areas for each appliance.

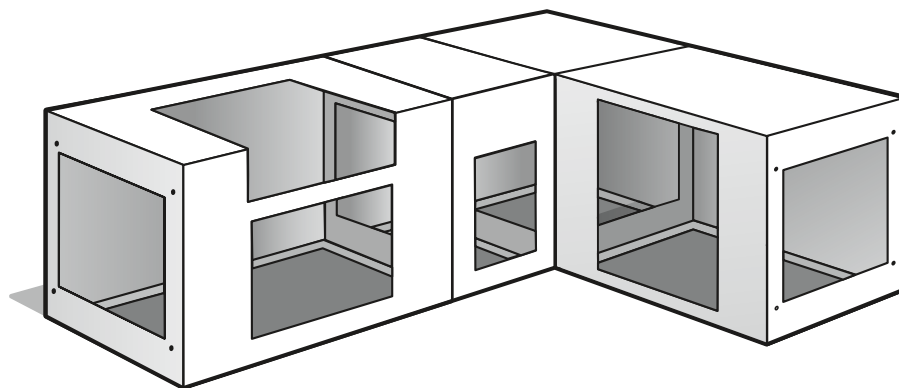



4

INSTALL APPLIANCES & COUNTERTOP .1

- A** Install an appropriate outdoor countertop surface such as tile or granite. If selecting a solid surface such as granite, it is recommended you work with a local fabricator.
- B** Refer to the appliance manufacturer's instructions for installation.
- C** Install doors and drawers in advance of stone installation.

INSTALL VENTS

- D** Vents are recommended by many grill manufacturers when installing into a closed cabinet. Check the appliance specifications for placement and quantity of vents required for proper cross ventilation.
- E** Position vents per specifications and mark area to be cut, making sure the opening is level and square.
- F** Cut opening with diamond radial saw: make sure to wear safety protection gear.
- G** Adhere vent to cabinet with construction adhesive.





4

INSTALL APPLIANCES & COUNTERTOP .2



INSTALL END-CAPS

- H** Locate each area where an end cap is needed to complete the island (in most cases, there should be two).
- I** Rotate the end cap until it firmly fits into the pre-formed location at the end of the island.
- J** Run a bead of construction adhesive around all four sides of the end cap opening.
- K** Once the construction adhesive becomes sticky, firmly push the end cap into place.
- L** Repeat these steps for each end cap.



5

INSTALL STONE OR BRICK .1



- A** Determine your choice of stone or brick, grout technique, and accents, if any.
- B** Use premixed Type N or Type S mortars. If applying a dry-stack grout technique, make sure to use a color-modified mortar to match the overall color hue of the stone being used.
- C** Layout a variety of stone/brick veneer sizes, shapes and colors from multiple boxes to ensure a proper mix.





5

INSTALL STONE OR BRICK .2



- D** Moisten the scratch coat and veneer to reduce initial absorption.
- E** Apply a 0.5" even layer of mortar to the entire back of veneer.
- F** Install corners first, alternating long and short returns. Next, wiggle face stones into place gently—*do not tap or hit stones*.
- G** Finalize installation by grouting joints unless a dry-stack grout technique is used.

For more details and comprehensive installation instructions, visit [mykindredliving.com](https://www.mykindredliving.com) before applying stone or brick to your Kindred Outdoor cabinets.



KINDRED

OUTDOORS + SURROUNDS

If you would like more information on this product or answers to any questions not covered in this manual, please contact us. We would be happy to assist you.

800.925.1491 www.mykindredliving.com