



KINDRED®

OUTDOORS + SURROUNDS





We are social creatures, meant to be together among the elements. To feel the crisp air over our sun-tired skin. To enjoy the warmth of a fire on our chilly toes. To take our coffees with the sunrise, and to trade stories into the night.

At Kindred Outdoors & Surrounds,  
drawing people together is what we do.

With hand-forged fire bowls, fireplace surrounds, and outdoor living spaces, we create atmospheres where people can commune, converse, and return to comfort. Spaces distinguished by craftsmanship, accentuated by firelight, and designed to draw us near.

It's a little bit of nature and a little bit nurture, all brought together into one kindred space, where we can be together among the elements.



## Elegant solutions for luxurious outdoor spaces

There's nothing quite like the pleasure of gathering friends and family in your own luxurious outdoor living space. With our outdoor products, there are a number of ways to create your very own personal retreat ranging from elegant fire bowls to inviting seating walls to beautiful outdoor kitchens. Kindred Outdoors & Surrounds seamlessly marries design and functionality making it easier than ever to create your memorable space.



## Fireplaces forged with the heritage of craftsmanship.

The fireplace is quite possibly one of the most dramatic spaces in any home. With the unique power to mesmerize, a fire draws us closer to its warmth. Such beauty and drama beckons for an elegant frame.

Our fireplace surrounds are handcrafted to create a distinctive one-of-a-kind appearance, normally only found with natural carved limestone. Explore the stylistic array of surrounds, ranging from contemporary to traditional designs.





# An Outdoor Architectural Statement



# Artisan Fire Bowls

## Warmth, Style & Ambiance.

Kindred Fire Bowls bring a heightened level of design and elegance to any outdoor space. Made from strong, glass-fiber reinforced concrete and hand-sanded through a four-step finishing process. Each Artisan Fire Bowl renders a true one-of-a-kind creation with subtle variations in color and texture similar to natural limestone. Fire Bowls ship complete with lava rock and match-lit components complying with CSA standards for natural gas or liquid propane. Choose from four colors in either Honed or Travertine finishes.



**Black Sand**  
Honed



**Black Sand**  
Travertine



**Aged Teak**  
Honed

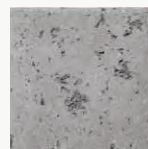

**Aged Teak**  
Travertine

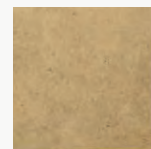

**Oak Barrel**  
Honed



**Oak Barrel**  
Travertine

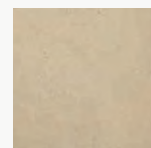

**Oyster Shell**  
Honed

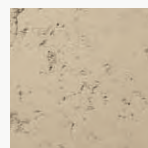

**Oyster Shell**  
Travertine

## Industry-Leading Burners



Patent-pending burner system comes complete with powerful 65,000 BTU burner, all brass fittings, heavy duty stainless steel platform and 10-year limited warranty. Innovative brass burner system uses half the fuel of conventional fire rings, yet produces higher flames and brighter appearance.



The **Infinite** in **Aged Teak** with a **Honed Finish**.

## Infinite™

The Infinite is limitless in its design applications. The simple, yet elegant shape will naturally draw attention for its style and inviting warmth. Perfect for both residential and commercial applications, the Infinite can change appearance from modern to traditional by selecting the textured Travertine finish.

**Dimensions: 36.25"Dia x 18.5"H**



The **Mezzaluna** in **Oyster Shell** with a **Honed Finish**.

## Mezzaluna™

Mezzaluna, which translates to half-moon in Italian, exhibits a low profile at only 15" high with a generous 48" circumference. Its perfect symmetry delivers an elegant simplicity to complement any aesthetic taste.

**Dimensions: 48"Dia x 15"H**



The **Marbella** in **Oak Barrel** with a **Travertine Finish**.

## Marbella™

The Marbella fire bowl captures the essence of Romanesque period. Its gently rounded bull nose and elegant foundation are hand-sanded, creating the natural feel and texture of limestone. The Marbella is perfect for a variety of traditional landscape settings.

**Dimensions: 38.25"Dia x 20.375"H**





## Kulm™

Experience the balance and symmetry of the elliptical Kulm fire bowl. Elegant and engaging, the sweeping lines soften the design while commanding attention in any environment.

**40" L x 20.25"W x 15"H**

**60" L x 28.75"W x 15"H**



The **Tuya** in **Black Sand** with a **Honed Finish**.

## Tuya™

Create a memorable outdoor area with high design and functionality. The versatile Tuya delivers the best of both worlds incorporating ample table space for entertaining along an artful circular fire feature.

**Dimensions: 60"L x 36"W x 15"H**



The **Talus** in **Black Sand** with a **Honed Finish**.

## Talus™

The monolithic square design of Talus creates an impressive contemporary centerpiece. Equally pleasing from all angles, this gently sloped circular fire feature will draw friends and family together.

**Dimensions: 40"Square x 15"H**



## Lyra™

Lyra exudes a modern linear design with a gently sloped fire feature. Sharp 90-degree inset walls add to this unique monolithic concrete design. The ideal application for any residential or commercial outdoor living space.

**42"L x 24"W x 15"H**

**60"L x 24"W x 15"H**





## Bloc™

Bloc delivers the perfect balance of simplicity and scale. At only 20" square, Bloc provides a surprising amount of warmth. Anchor small seating areas or highlight outdoor elements with this handsome fire feature.

**Dimensions: 20"Square x 15"H**



## Propane Tank Enclosure

When using liquid propane, select a matching Propane Tank Enclosure to discreetly house the tank and create an elegant end table. Available in all the Kindred Fire Bowl colors and finishes.

**Dimensions: 19"D x 19"W x 22.375"H**



The **Equa** in **Oyster Shell** with a **Honed Finish**.

## Equa™

The subtle curves of the Equa fire bowl form a pleasing shape ideal for intimate conversation spaces or a personal retreat. Begin or end your day with a cup of relaxation, a favorite book and ample warmth.

**Dimensions: 20"Dia x 15"H**



The Artisan Fire Bowl **Wood Table Top** shown on the **Infinite**.

## Wood Table Tops

Extend the use of your artisan fire bowl with our customized high quality Iroko wood table tops. Available for all fire bowl designs.



# Signature Kitchens™



Pre-Designed, Ready to Install. Signature Kitchens allow you to construct the perfect outdoor kitchen in days vs. weeks. Each kitchen has been pre-designed to fit a variety of size and style configurations and ship complete with all necessary cabinets, bolts and end-caps. Finalize your outdoor design by selecting a stone finish, appliances and countertop material of your choice.



The **ParkView** Signature Kitchen installed with an ashlar stone.

## ParkView™

**Includes:**

- 1 Qty. 24" Straight Cabinet
- 1 Qty. 48" Straight Cabinet
- 1 Qty. 60" Straight Cabinet
- 1 Qty. 90° Corner Cabinet
- 2 Qty. Cabinet End Caps
- 3 Qty. Fastener Sets
- 2 Qty. Vents

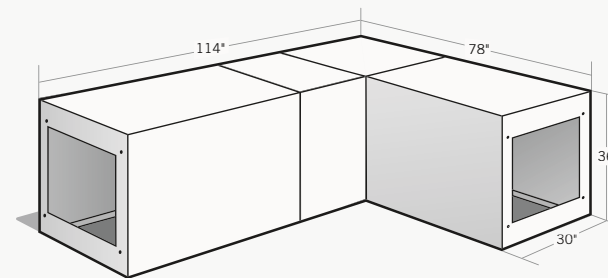

## CoastalRanch™

The **CoastalRanch** Signature Kitchen installed with installed with a fieldedge stone.

**Includes:**

- 2 Qty. 24" Straight Cabinets
- 1 Qty. 48" Straight Cabinet
- 1 Qty. Bar-Height 90° Corner Cabinet with 10" Cantilever
- 2 Qty. Bar-Height Cabinet with 10" Cantilevers
- 2 Qty. Cabinet End Caps
- 5 Qty. Fastener Sets
- 2 Qty. Vents

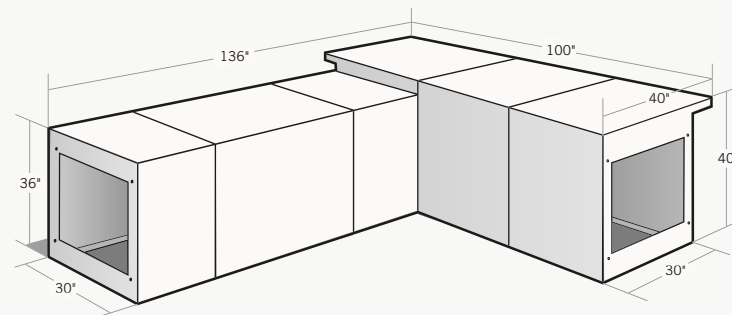

The **Metropolitan** Signature Kitchen installed with a stacked stone.

## Metropolitan™

**Includes:**

- 1 Qty. 36" Straight Cabinet
- 1 Qty. 48" Straight Cabinet
- 1 Qty. 60" Straight Cabinet
- 2 Qty. Cabinet End Caps
- 2 Qty. Fastener Sets
- 2 Qty. Vents

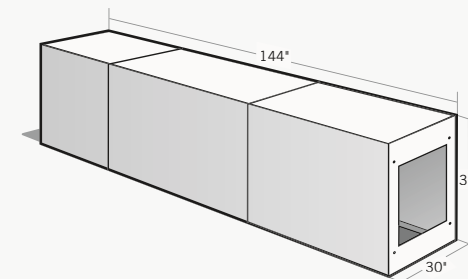



# Outdoor Luxury Made Simple, In Just 5 Steps!

## Building Blocks

Kindred Outdoors has redefined how to build outdoor living spaces with a collection of strong, yet lightweight building blocks. The blocks quickly assemble into custom barbecue islands, fireplaces, fire pits and more—ready to be dressed with stone or brick within hours.



The **Metropolitan** Signature Kitchen installed with a stacked stone.

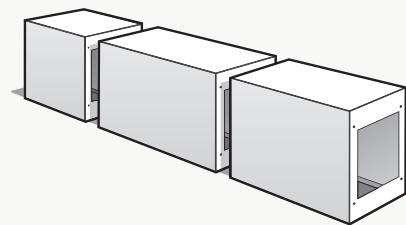

**Step 1** Pre-Planning & Design

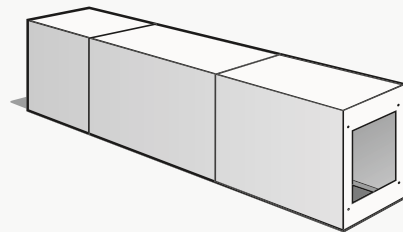

**Step 2** Install Kindred Outdoors Cabinets

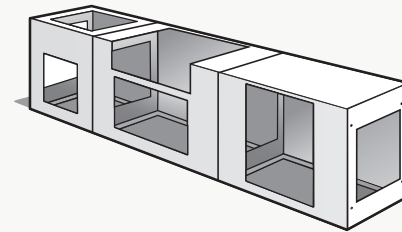

**Step 3** Cut Appliance Openings

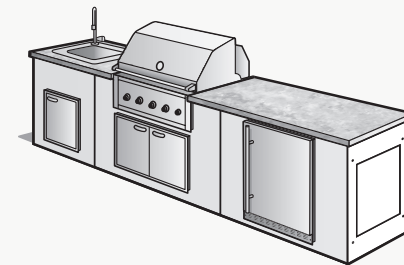

**Step 4** Install Appliances & Countertop

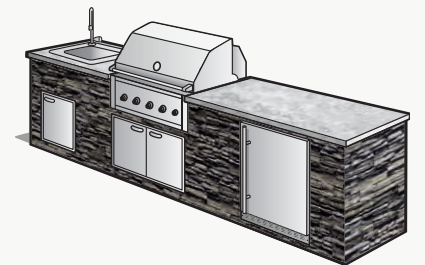

**Step 5** Install stone or brick finish.

# Kindred Outdoors vs. Concrete Block

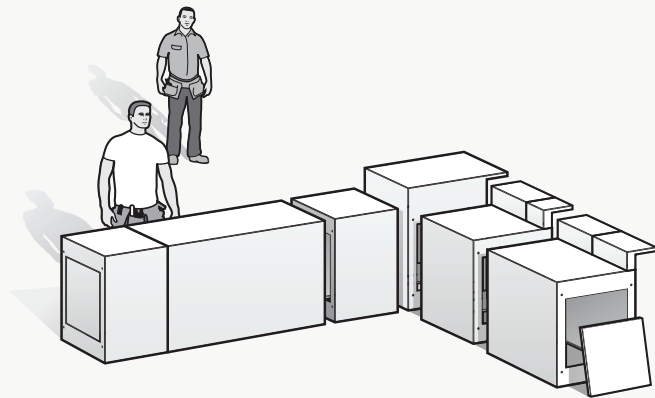

## Kindred Outdoors:

- 6 Outdoor Cabinets
- 4 Raised Backsplashes
- 2 End Caps
- Hand Tools
- 2 People
- 1 Day**



## CMU Concrete Block:

- 160 Qty. Concrete Blocks
- 200 Ft. Rebar
- 45 Qty. Bags of Cement
- Heavy Equipment
- 4 People
- 7 Days**



The sheer magnitude of materials, time and manpower required to build a CMU Concrete Block kitchen compared to Kindred Outdoors is well illustrated in this “example.” Kindred Outdoors allows you to create beautiful and authentic masonry outdoor spaces in less than half the time compared to traditional building techniques. The strong, yet lightweight material doesn’t require additional concrete footings, bending rebar, or any of the mess, waste and time associated with CMU installations.



Kindred Outdoors Cabinets finished with a fieldledge stone.



## 90° Corner Cabinets

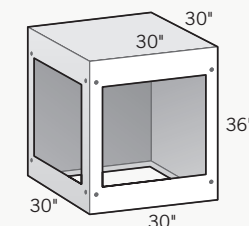

**90° Corner Cabinet**  
30"D × 30"L × 36"H

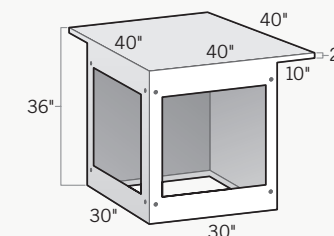

**90° Corner Cabinet with 10" Cantilever on Two Sides**  
30"D × 30"L × 36"H

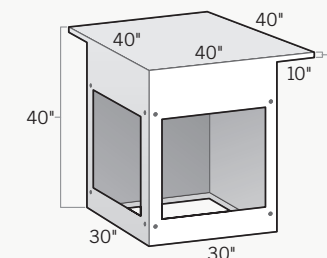

**Bar-Height 90° Corner Cabinet with 10" Cantilever on Two Sides**  
30"D × 30"L × 40"H

## Cabinets & Accessories

The Building Blocks. Kindred Outdoors products quickly assemble into a virtually limitless combination of configurations. Each piece is made of glass-fiber reinforced concrete (GFRC) which can be installed on any solid flooring surface without concrete footings or rebar. Eliminated is the

construction waste and additional time associated with traditional masonry block installations. Kindred Outdoors products can be assembled in just hours; even cut-outs for barbecues, sinks, drawers and burners can be done on-site.

## Walls, Columns & Accessories



### Straight (Linear) Cabinets

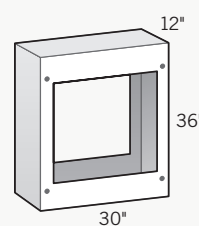

**12" Cabinet**  
30"D × 36"H

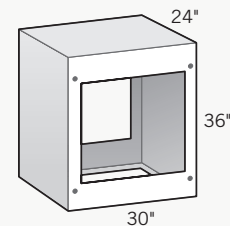

**24" Cabinet**  
30"D × 36"H

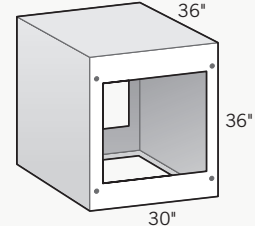

**36" Cabinet**  
30"D × 36"H

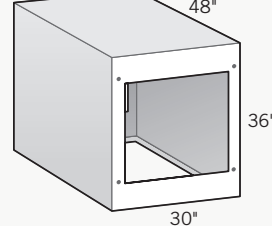

**48" Cabinet**  
30"D × 36"H

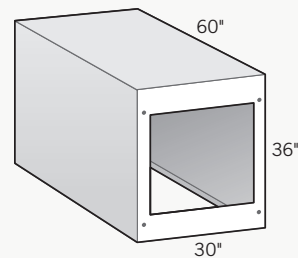

**60" Cabinet**  
30"D × 36"H

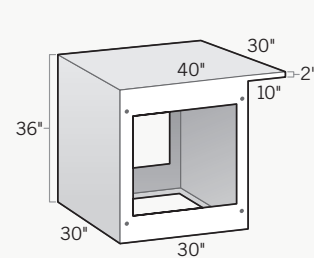

**Cabinet with 10" Cantilever Backside**  
30"D × 30"L × 36"H

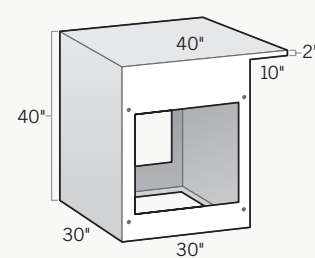

**Bar-Height Cabinet with 10" Cantilever Backside**  
30"D × 30"L × 40"H

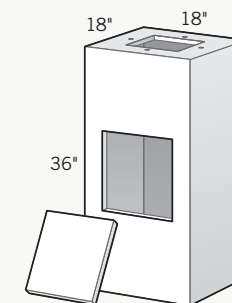

**Column with End Cap**  
18"D × 18"L × 36"H

Instantly build perfect stone or brick columns/ Column ships with access panel. Designed with top and bottom flange for attaching masonry anchor or bolting.

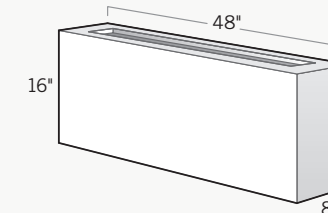

**Straight Seating Wall**  
8"D × 48"L × 16"H

Create seating walls in hours vs. days. Finish with Eldorado Stone & Wall Caps for an authentic masonry appearance.

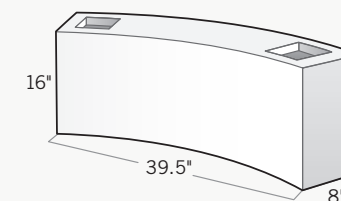

**Curved Seating Wall (1/8 Circle)**  
8"D × 39.5"L × 16"H

Curved seating wall is designed with a 51" radius from the center point to the inside edge, perfect for pairing with our round fire pit.

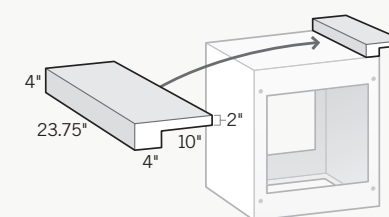

**Straight Raised Backsplash**

Creates 4" high raised backsplash (23.75" long) with 10" cantilever and 14" counter surface. Requires 3 bolts for mounting (not included).

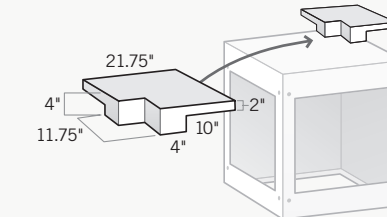

**Corner Raised Backsplash**

Creates a 4" high raised corner backsplash with a 10" cantilever; connects to straight raised backsplash for L-shaped configurations. Requires 2 bolts for mounting (not included).

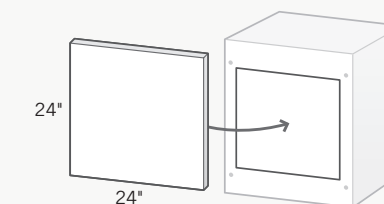

**Cabinet End Cap**  
24" × 24"sq

End Caps complete the installation by closing off openings on either end of assembled island.

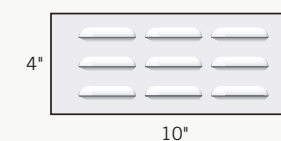

**Vent**

Vents are recommended by many barbecue appliance manufacturers when installing gas appliances into a closed cabinet.



**Appliance Bracket Set**

Includes 2 brackets & screws for use with drawers, doors, etc. Works with flanges to secure items in cabinet cut-outs.

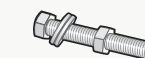

**Fastener Set**

Includes 4 nuts, 4 bolts & 8 washers. One fastener set is required to secure two cabinets.



# Fireplaces & Fire Pits

Inviting Fireside Chats. Sitting fireside in your backyard has never been easier. Choose from our unique design options and fuel types for Fireplaces and Fire Pits. Each Fireplace and Fire Pit are ready to be dressed with stone or brick for the ultimate masonry appearance.

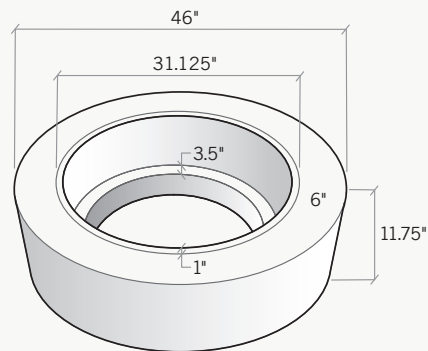

## Kittredge™ Gas-Burning Fire Pit

The Kittredge Fire Pit is the perfect centerpiece to your outdoor room. Combine it with our curved seating walls which match the radius perfectly and you're bound to start some great fireside conversations.

**Dimensions: 46"Dia x 11.75"H**



The Kittredge Fire Pit finished with a ledgerstone.



## Wilmington™ Gas-Burning Fireplace

The Wilmington Fireplace features architectural touches such as an arched opening and cantilevered mantel for an elegant design. Delivered complete with a scratch-coat surface, the Wilmington can be finished for an impressive custom masonry appearance.

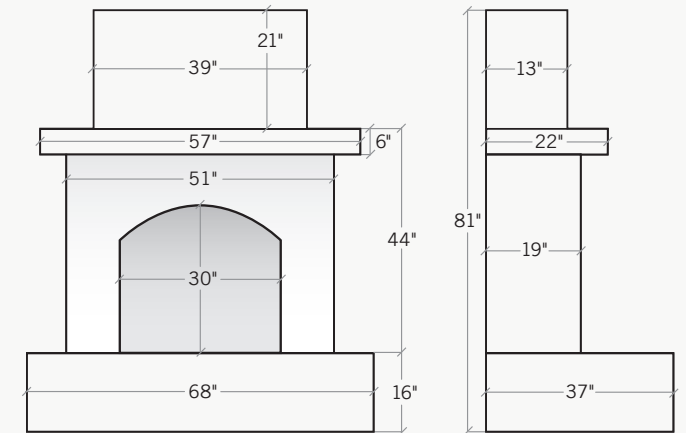

**Wilmington Gas-Burning Fireplace**  
37"D × 68"L × 81"H

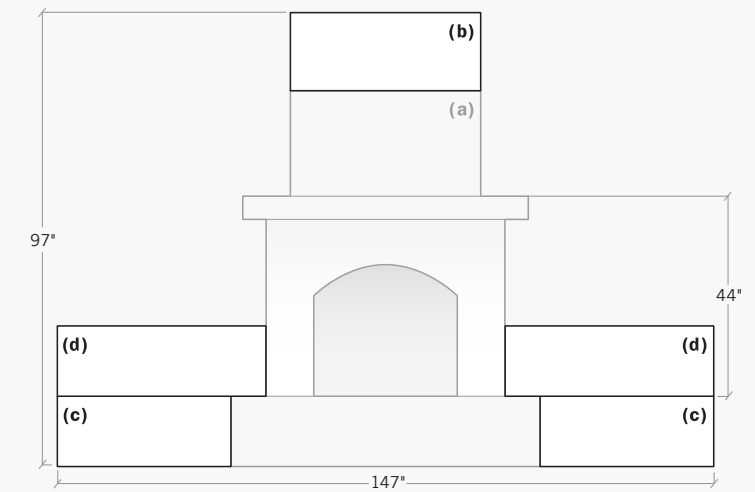

**Gas-Burning Fireplace Extensions**  
(a) Gas-Burning Fireplace | (b) Chimney Extension  
(c) Hearth Extension | (d) Hearth Extension Backrest

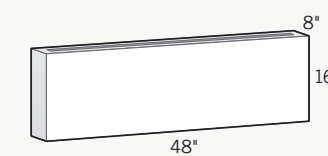

**Wilmington Gas-Burning Fireplace  
Hearth Extension Backrest**  
8"D × 48"L × 16"H

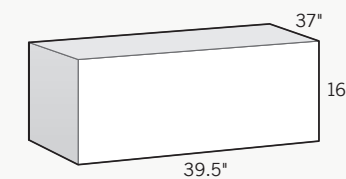

**Wilmington Gas-Burning  
Fireplace Hearth Extension**  
37"D × 39.5"L × 16"H

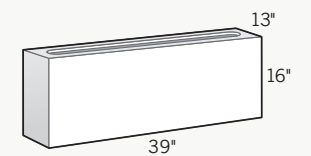

**Wilmington Gas-Burning  
Fireplace Chimney Extension**  
13"D × 39"L × 16"H

# Sherwood™

## Wood-Burning Fireplace

The Sherwood Fireplace creates a focal point in your open air conversation setting while providing the warmth and pleasant crackle of burning wood. A design statement, the Sherwood can be dressed with any stone and accessories to complement and enhance your outdoor living space.

**Dimensions: 47"D x 96"L x 93"H**

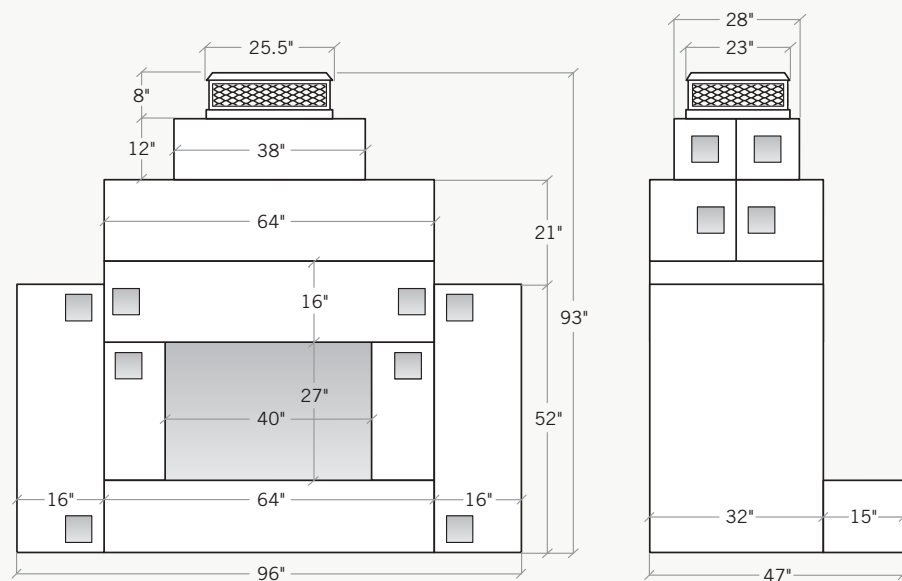

The Sherwood Fireplace finished with a stacked stone.





# Fireplaces Forged with the Heritage of Craftsmanship



# Fireplace Surrounds

## Handcrafting a Custom Work of Art

Kindred Outdoors & Surrounds has demonstrated an undeniable passion for creating authentic products that not only elevate quality and design, but also attainability. Our commitment to this philosophy continues with our striking collection of Kindred Fireplace Surrounds.

Our fireplace surrounds are designed to bring elegance and warmth to a wide variety of architectural styles. It all begins with a proprietary blend of limestone aggregates, minerals, natural pigments and special bonding agents. The material is hand applied layer by layer into the mold—creating natural color and texture variations—guaranteeing no two surrounds are exactly alike. Once the surround is removed from the mold, our skilled artisans hand finish each piece through a four-step finishing process. The distinctive one-of-a-kind process creates a highly authentic appearance which would normally only be found with natural carved limestone. Similar to natural limestone, variations in color and texture are celebrated characteristics of the product.



## The Colors and Textures of Authenticity.

Kindred Fireplace Surrounds are available in four colors—designed to represent the various types of natural limestones found across France and other parts of Europe. Choose from two finishes including Honed, a smooth texture, or Travertine, a more textured surface. Both finishes include color and texture variations, providing the authentic character and attributes of natural stone.



**Black Sand**  
Travertine



**Black Sand**  
Honed

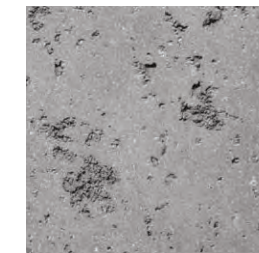

**Aged Teak**  
Travertine



**Aged Teak**  
Honed



**Oak Barrel**  
Travertine



**Oak Barrel**  
Honed

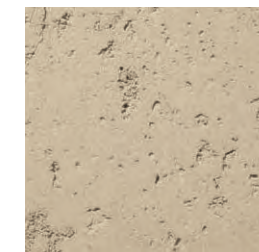

**Oyster Shell**  
Travertine



**Oyster Shell**  
Honed



## The Carmela™

The Carmela is layered with visual interest beginning with its plinth block foundation and linear legs framed with a unique bull nose detail. The 11.5" depth mantel provides ample space for decor.

**11.5"D x 70"W x 52.75"H**

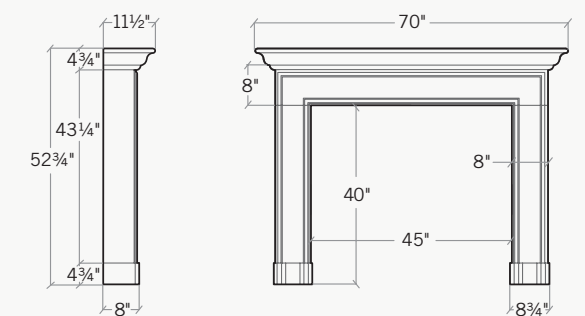



The **Giada** in **Oyster Shell** with a **Honed Finish**.

## The Giada™

The pleasing blend of clean lines and finite details invite this surround into both contemporary and transitional settings. The 8" monolithic depth gives way to the deeply carved and symmetrical properties.

**Dimensions: 8"D x 67"W x 52"H**

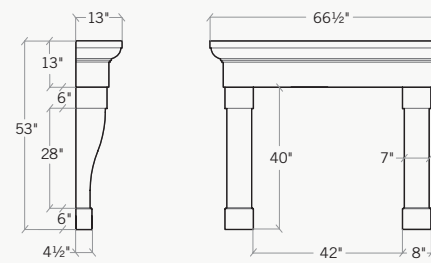
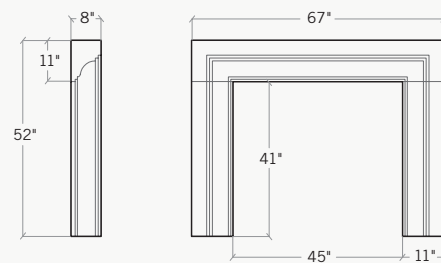

The **Valentina** in **Oak Barrel** with a **Travertine Finish**.

## The Valentina™

The Valentina will invite a sense of rustic Italian charm into any home. The robust 13" deep mantel paired with two gently sloping pilasters complete its bold presence.

**Dimensions: 13"D x 66.5"W x 53"H**



## The Sofia™

The understated elegance of The Sophia combines both straight lines and flowing curves. The long-established shape works well with traditional settings.

**9.5"D × 72"W × 52.75"H**

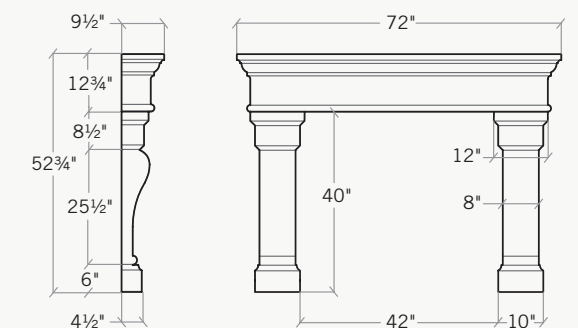



The **Dylan** in **Aged Teak** with a **Honed Finish**.

## The Dylan™

The modern sophistication of The Dylan is evident with its extremely clean lines. The surrounding beveled edges create a distinctive architectural detail.

**Dimensions: 6"D x 62"W x 51"H**

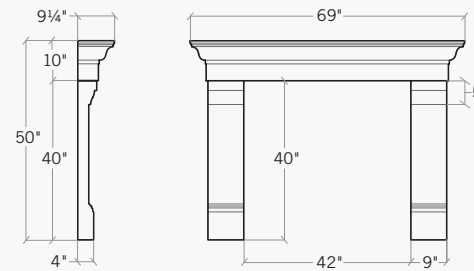
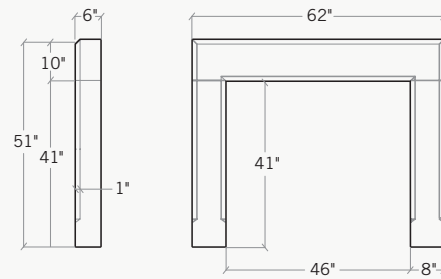

The **Florentina** in **Oyster Shell** with a **Honed Finish**.

## The Florentina™

The simple and classical shape creates the perfect frame for a wide variety of fireplace settings. The 9" mantel depth provides ample area to stylize to your specific interior design.

**Dimensions: 9.25"D x 69"W x 50"H**



## The Soho Boutique™

The Soho Boutique is smaller in scale, yet its clean lines imply a sense of luxury and timeless style.

**7"D × 61"W × 49.5"H**

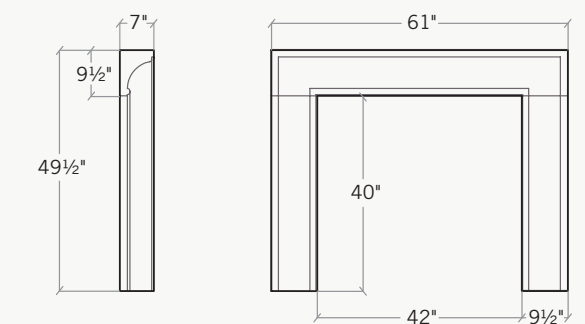



The **Annalisa** in **Oak Barrel** with a **Honed Finish**.

## The Annalisa™

Elegance and beauty adorn The Annalisa with its gently sloping arch and detailed carvings. Its scale is designed for larger rooms, perfectly suited for elegant and casual settings alike.

**Dimensions: 12"D x 76.5"W x 64"H**

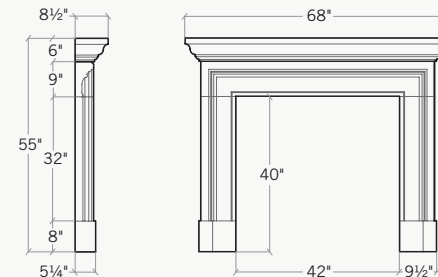
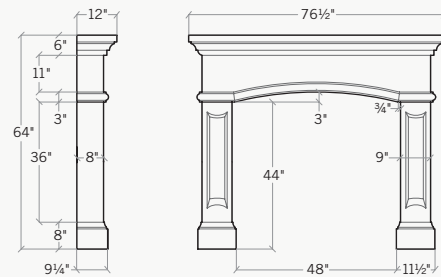

The **Bryant** in **Oak Barrel** with a **Travertine Finish**.

## The Bryant™

The Bryant is an elegant surround that transcends all design styles with multiple layers of intricate yet linear carvings. The base blocks further enhance its stature and solid stance.

**Dimensions: 8.5"D x 68"W x 55"H**





## The Palacio™

The grand form of The Palacio will draw you closer with its impressive size and bold stature. The commanding presence will easily become the focal masterpiece of any luxurious space.

**19.5"D x 84"W x 63"H**

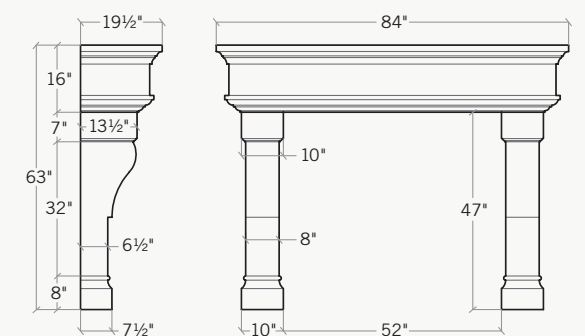

The Palacio in Oak Barrel with a Travertine Finish.



The Angelo in Oak Barrel with a Travertine Finish.

## Mantel Shelves



### The Martino

Strong lines and crisp curves make this versatile shelf especially stunning in a modern home. 8" h x 9" d in either 48" or 60" lengths. Available in all the Kindred Fireplace Surround colors and finishes.

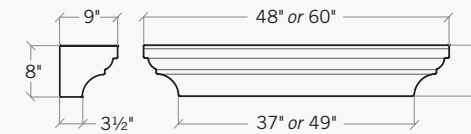

### The Angelo

Sweeping curves make this shelf an elegant mantel to grace the walls of any home. 9" h x 9" d in either 48" or 60" lengths. Available in all the Kindred Fireplace Surround colors and finishes.

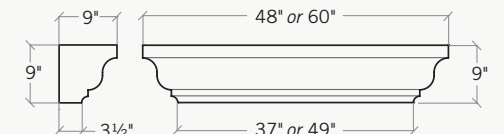

## Hearth Stones & Riser Blocks



### Hearth Stones

Available in all the Kindred Fireplace Surround colors and finishes. Sold in sets of three with one left, center & right stone and also individually (single center stone).

**20"D x 24"W x 2"H Each**

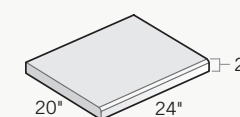

### 8" Hearth Riser Blocks

Available in all the Kindred Fireplace Surround colors and finishes. Sold in sets of three or individually. Finishes hearth at 10" high with hearth stones; may be trimmed to accommodate shorter heights.

**19"D x 23.375"W x 8"H Each**

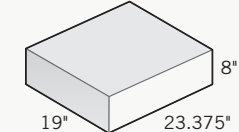



# KINDRED

OUTDOORS + SURROUNDS

## Please Note:

Because Kindred Outdoors & Surrounds finishes replicate natural stone, variations should, and can be expected. Even though colors in this brochure are as close to the actual product as possible, photographic and printing techniques — and actual viewing conditions — can alter perception of color. It is recommended to obtain a sample of a Kindred Outdoors & Surrounds finish before ordering.

If you would like more information on prices, availability of products, the name of your local distributor, or answers to any questions not covered in this brochure, please contact us. We would be happy to assist you with your building plans. Detailed installation instructions, specifications, technical information and test data is available upon request.

**800.925.1491 [www.MyKindredLiving.com](http://www.MyKindredLiving.com)**